

Ecosystem of digital identities

Introductory presentation

July 2021



Introduction of digital identity

Overall context: Project Ecosystem of Digital Identities

European dimension

Identity has many facets – and is significantly more than the information on the identity card



I studied medicine

I'm married

I have an income of ...

I own residential property

I have children

I am of legal age

I have a high school diploma

I am a doctor

„Identity is the totality of the peculiarities that [...] characterize an object and distinguish it as an individual from others.“

Certain claims must be regularly proven in everyday life by credentials

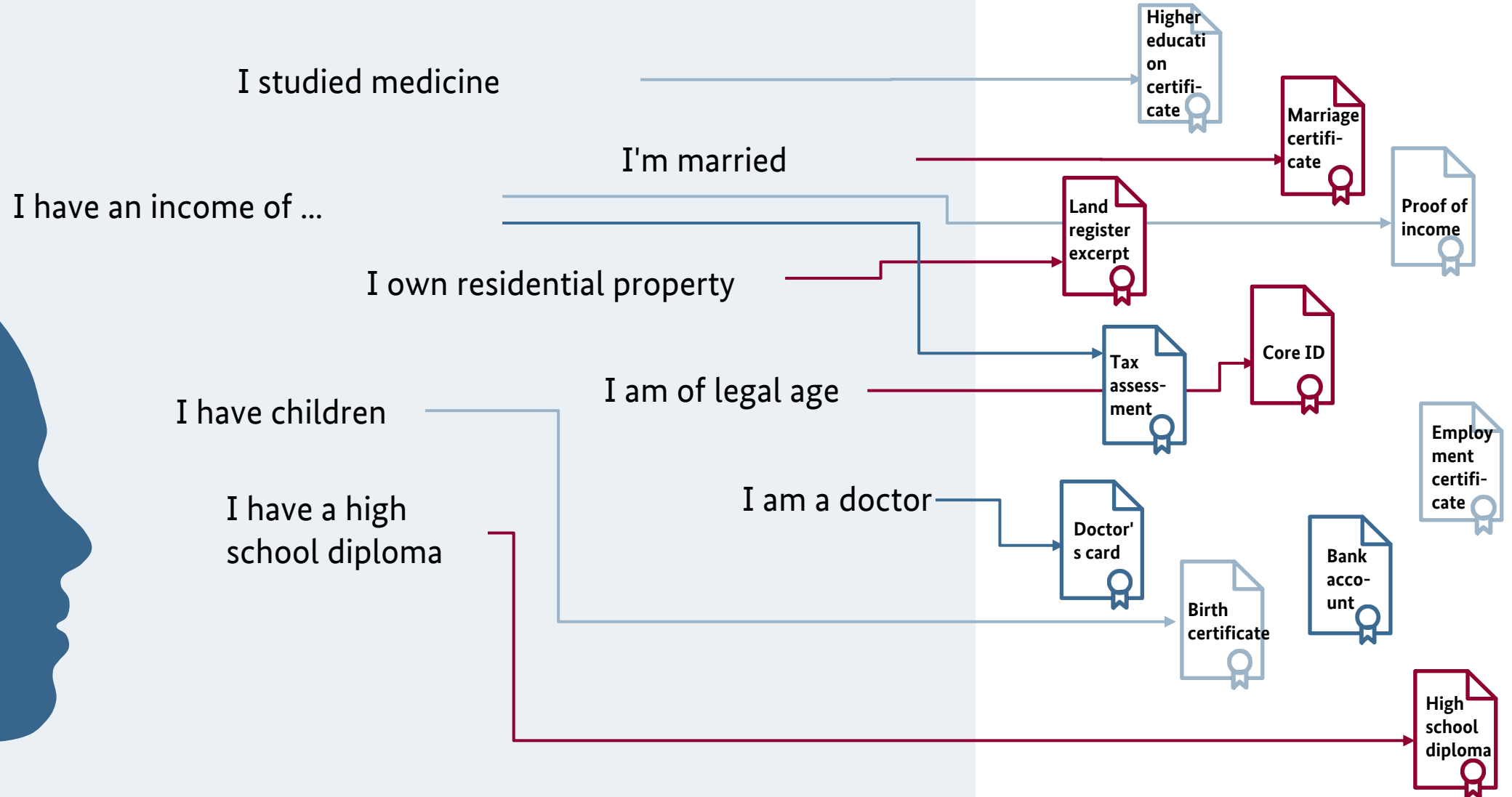

Verifiable digital credentials are a central prerequisite for many digital services

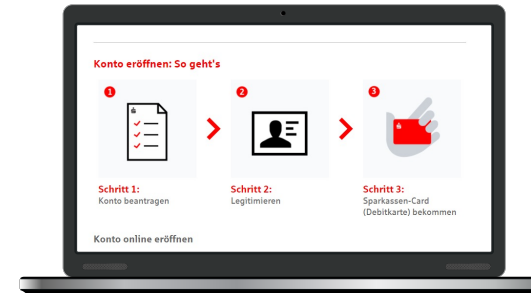
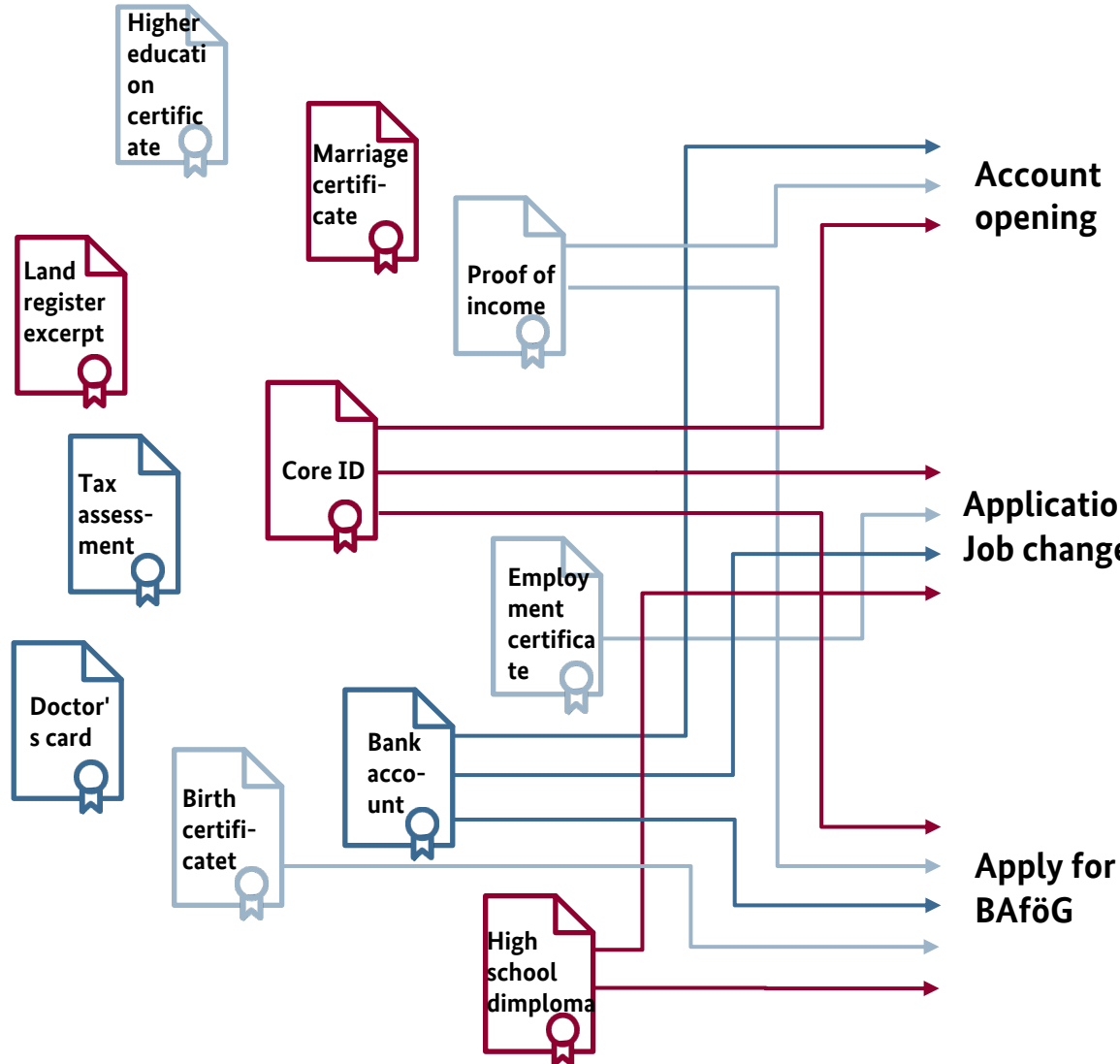

Lack of digital credentials is one of the biggest obstacles to digitalization of our time

According to a study, digital identities can enable economic benefits equivalent to 3-4% of GDP in 2030



3 - 4%

The economic benefits equivalent to GDP in 2030 that digital identities in mature economies could release per country¹



995

Billion USD



97

Examples of how digital identities can create value¹

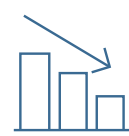

Savings in retail through optimization of supply chains & operation

6

5

Billion USD



Savings through seamless and secure exchange of medical information

5,3

3,3

% value creation in the healthcare sector³



Time savings for citizens when using eGovernment services

4400

500

Millions of hours



Cost savings through reduction of wage fraud²

2

1

% of total wages

1. Estimates include the full benefits of digital identity use cases, provided that a high level of acceptance is achieved by 2030, the required digital infrastructure and ecosystem has been built, and complementary investments have been made

2. Removal of unauthorized or partly no longer existing employees ("ghost employees") from the payrolls of the administration and the private sector

3. Forecast for 2030 based on combination of data from MGI study with size of the health sector (= value added in the health sector) of GDP in 2030 by IHS Markit

All relevant verifiable and personalized proofs should be available to the user digitally, e.g. in a wallet

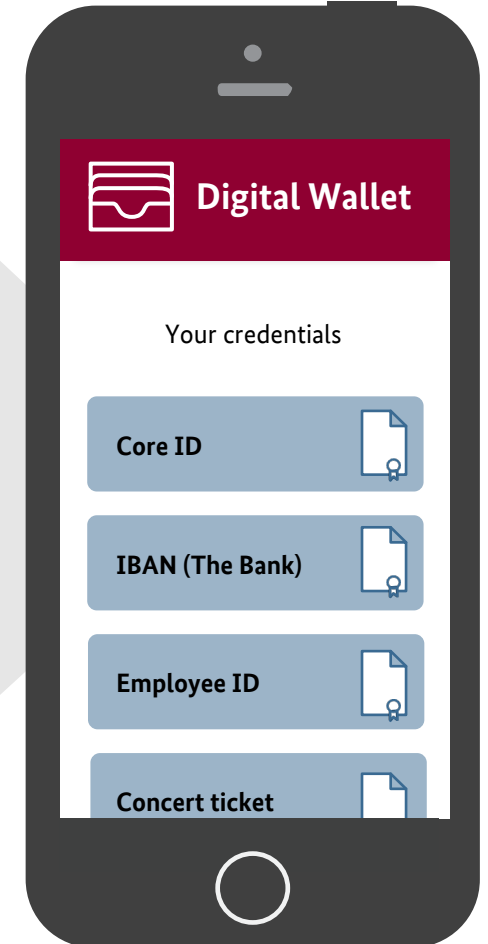
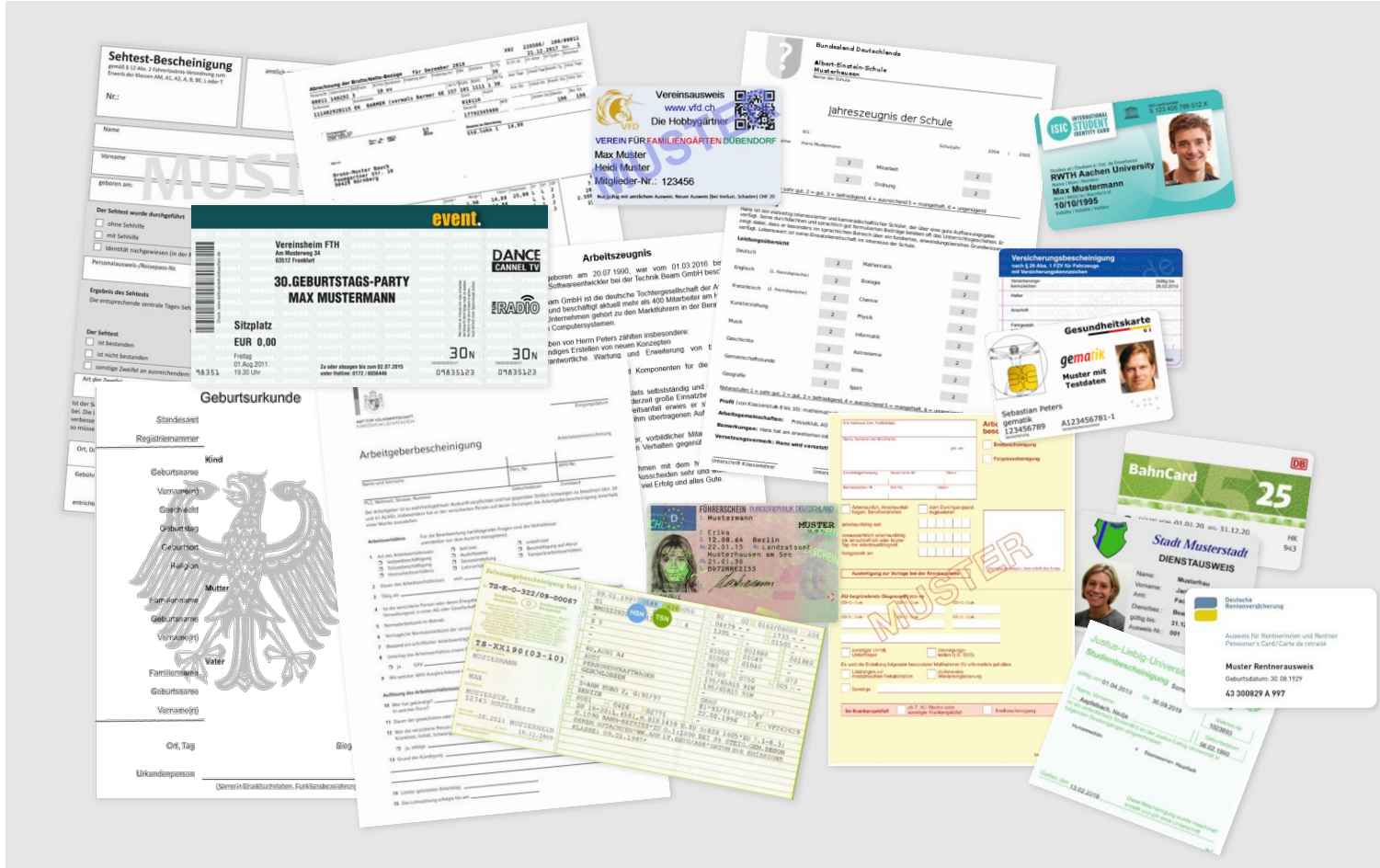

Introduction of digital identity

Overall context: Project Ecosystem of Digital Identities

European dimension









Our vision is a European ecosystem of digital identities

Example of ecosystem use case





Digital Wallet

-  Core ID 
-  Confirmation of freedom from rent debt 
-  SCHUFA information 
-  Proof of income 



Vision

A European ecosystem for the seamless, secure and verifiable exchange of credentials

- 

The use of the ecosystem is linked to transparent organizational, legal and technical standards
- 

It is an open, non-discriminatory ecosystem – anyone can participate as long as they are in compliance with standards
- 

Connectivity to the ecosystem is easy to implement, and easy to use for citizens and institutions

The basis for the ecosystem is the SSI approach – citizens in the center with full sovereignty over their own data

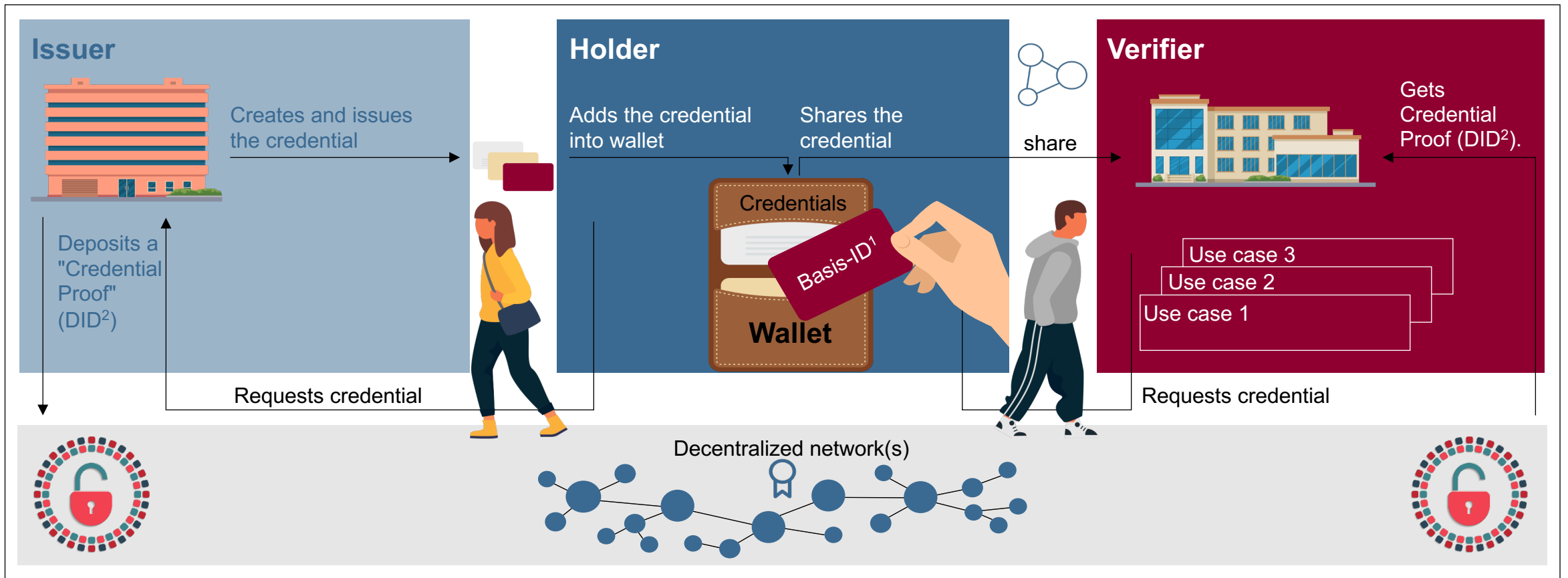

In concrete terms, this means for the use cases that are selected within the framework of the project:



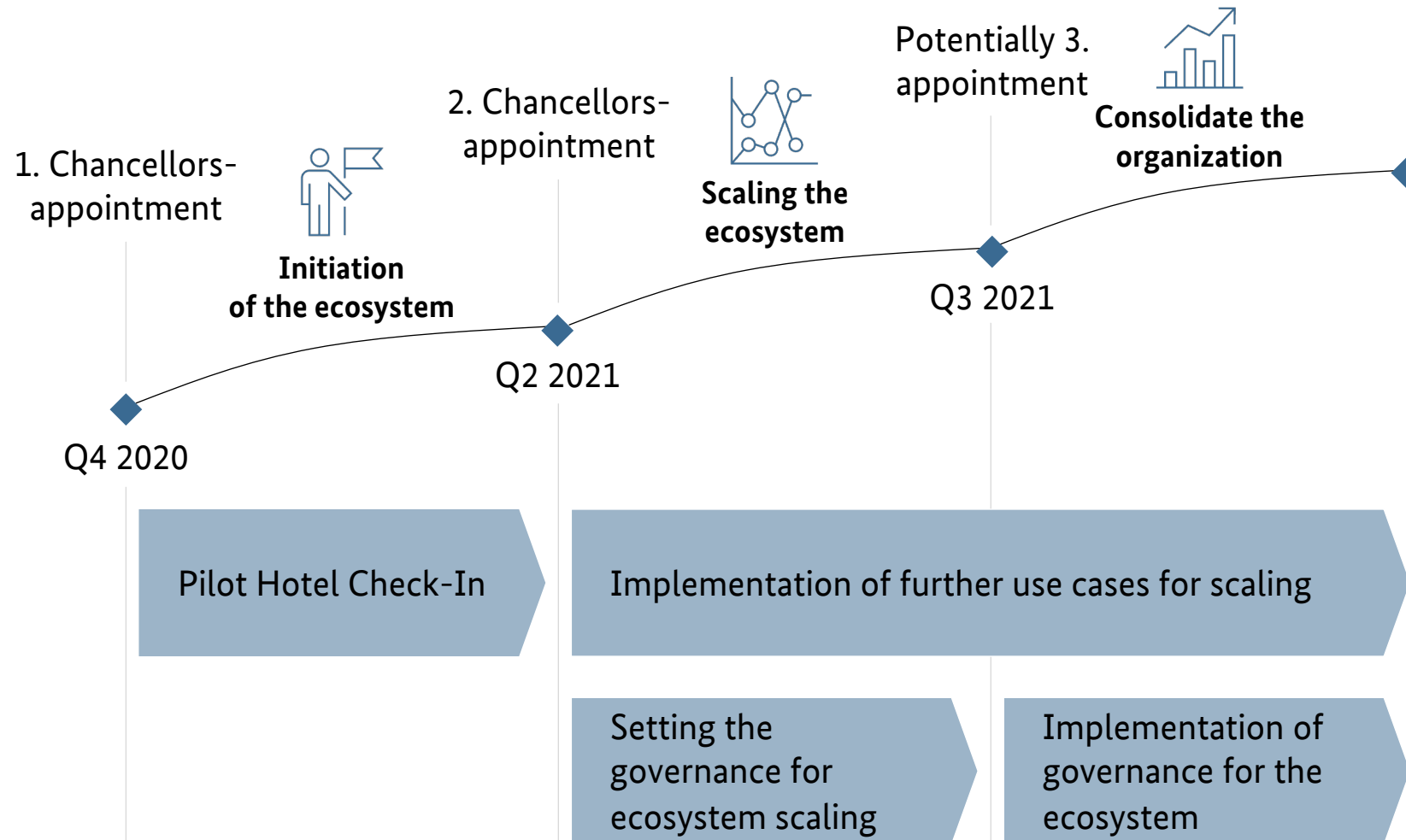

- Credentials are issued according to SSI standards
- Verification of the credentials should be carried out for the duration of the project via the SSI-based network provided by the project
- By using an SSI-based wallet, the holder/user is the only entity with full control over their own data

After the implementation of the hotel check-in, further use cases are already being implemented



The **pilot for hotel check-in creates a first use case** in close cooperation between the Federal Government and the private sector

To **further scale the ecosystem**, use cases from the following areas are currently being implemented:

-  Operational access management for internal/external employees
-  Driver's license verification for fleet management
-  Registration for prepaid contracts
-  Customer account registration / recurring log-in for e-commerce
-  Online account / securities account opening at banks

Introduction of digital identity

Overall context: Project Ecosystem of Digital Identities

European dimension

EU-wide momentum for digital identity – fast cross-border implementation in preparation

Press release | 3 June 2021 | Brussels

Commission proposes a trusted and secure Digital Identity for all Europeans

The European Digital Identity framework

“Under the new Regulation, Member States will offer citizens and businesses **digital wallets** that will be able to link their national digital identities with proof of other personal attributes (e.g. driving license, diplomas, bank account). These wallets may be provided by public authorities or by private entities, provided they are recognized by a Member State.”

EU commission publicly requested EU member states to establish a common **toolbox** by September 2022 **including:**



Technical architecture



Standards



Best practice guidelines